

# PUBLIC ADDRESS AMPLIFIER

## User's Manual



---

**TABLE OF CONTENTS**

---

**01 INTRODUCTION**

**02 CONTROL ELEMENT**

**04 BACK GROUND MUSIC MODULE DESCRIPTION**

**08 BLOCK DIAGRAM**

**09 SPECIFICATION**

**10 CONNECTION DESCRIPTION**

**CONNECTION DESCRIPTION**

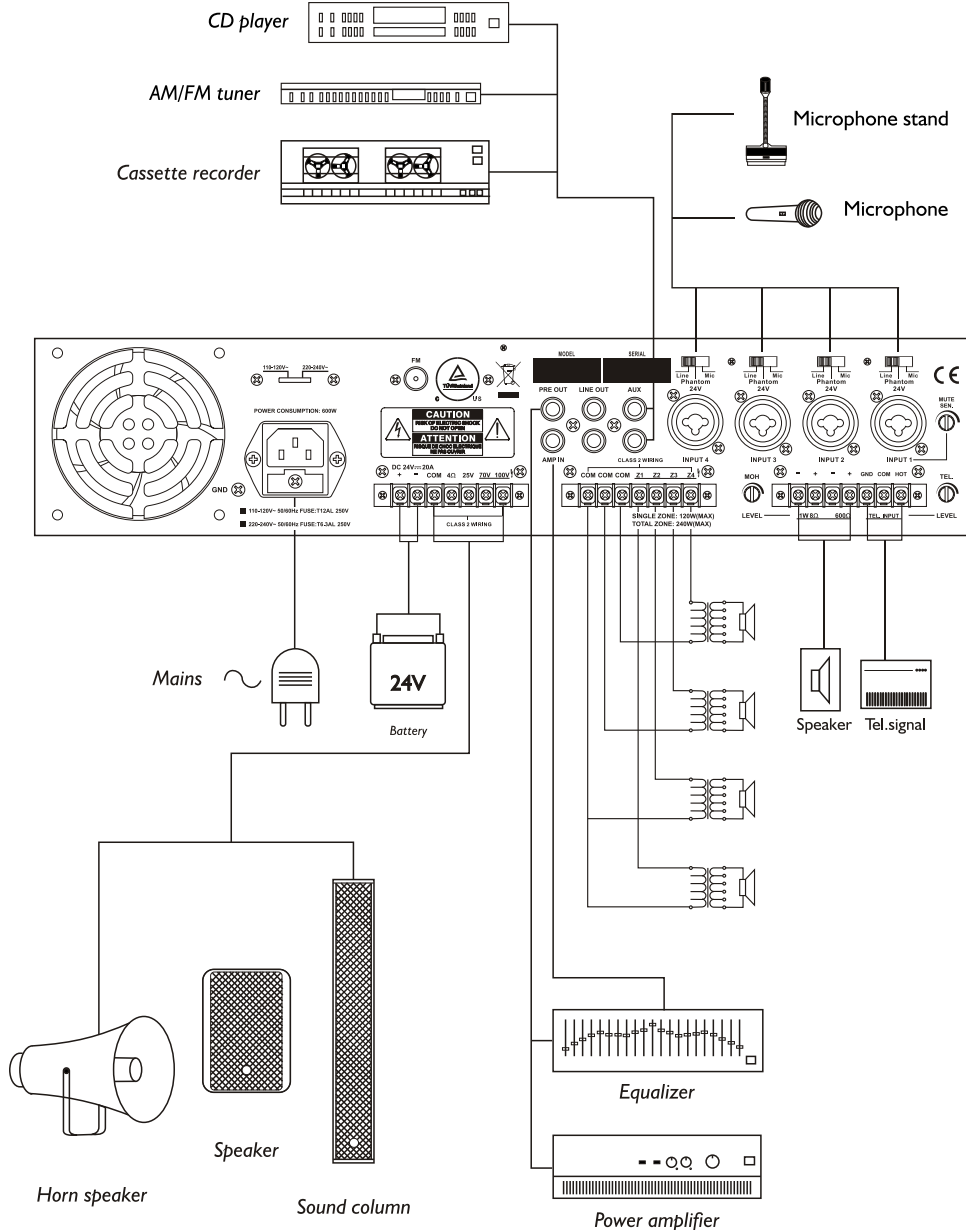

**SAFETY RELATED SYMBOLS**



The symbol is used to indicate that some hazardous live terminals are involved within this apparatus, even under the normal operating conditions.



The symbol is used in the service documentation to indicate that specific component shall be only replaced by the component specified in that Documentation for safety reasons.



Protective grounding terminal.



Alternating current /voltage.



Hazardous live terminal .

ON: Denotes the apparatus turns on.

OFF: Denotes the apparatus turns off, because of using the single pole switch, be sure to unplug the AC power to prevent any electric shock before you proceed your service.

**WARNING:** Describes precautions that should be observed to prevent the danger of injury or death to the user.



Disposing of this product should not be placed in municipal waste and should be separate collection.

**CAUTION:** Describes precautions that should be observed to prevent danger of the apparatus.

**WARNING**

**• Power Supply**

Ensure the source voltage matches the voltage of the power supply before turning ON the apparatus.

Unplug this apparatus during lightning storms or when unused for long periods of time.

**• External Connection**

The external wiring connected to the output hazardous live terminals requires installation by an instructed person, or the use of ready-made leads or cords.

**• Do not Remove any Cover**

There are maybe some areas with high voltages inside, to reduce the risk of electric shock, do not remove any cover if the power supply is connected.

The cover should be removed by the qualified personnel only.

No user serviceable parts inside.

**• Fuse**

To prevent a fire, make sure to use fuses with specified standard (current, voltage, type). Do not use a different fuse or short circuit the fuse holder.

Before replacing the fuse, turn OFF the apparatus and disconnected the power source.

**• Protective Grounding**

Make sure to connect the protective grounding to prevent any electric shock before turning ON the apparatus.

Never cut off the internal or external protective grounding wire or disconnect the wiring of protective grounding terminal.

**• Operating Conditions**

This apparatus shall not be exposed to dripping or splashing and that no objects filled with liquids, such as vases, shall be placed on this apparatus.

To reduce the risk of fire or electric shock, do not expose this apparatus to rain or moisture.

Do not use this apparatus near water. Install in accordance with the manufacture-r's instructions. Do not install near any heat sources such as radiators, heat registers, stoves, or other apparatus (including amplifiers) that produce heat. Do not block any ventilation openings.

No naked flame sources, such as lighted candles, should be placed on the apparatus.

### IMPORTANT SAFETY INSTRUCTIONS

- Read these instructions.
- Follow all instructions.
- Keep these instructions.
- Heed all warnings.
- Only use attachments/accessories specified by the manufacturer.

#### • Power Cord and Plug

Do not defeat the safety purpose of the polarized or grounding type plug.

A polarized plug has two blades with one wider than the other. A grounding type plug has two blades and a third grounding prong. The wide blade or the third prong are provided for your safety. If the provided plug does not fit into your outlet, consult an electrician for replacement of the obsolete outlet.

Protect the power cord from being walked on or pinched particularly at plugs, convenience receptacles, and the point where they exit from the apparatus.

#### • Cleaning

When the apparatus needs a cleaning, you can blow off dust from the apparatus with

a blower or clean with rag etc.

Don't use solvents such as benzol, alcohol, or other fluids with very strong volatility and flammability for cleaning the apparatus body. Clean only with dry cloth.

#### • Servicing

Refer all servicing to qualified personnel. To reduce the risk of electric shock, do not perform any servicing other than that contained in the operating instructions unless you are qualified to do so .

Servicing is required when the apparatus has been damaged in any way , such as power supply cord or plug is damaged , liquid has been spilled or objects have fallen into the apparatus, the apparatus has been exposed to rain or moisture , does not operate normally, or has been dropped.

The mains plug is used as the disconnect device, the disconnect device shall remain readily operable.

### TECHNICAL SPECIFICATIONS

RMS output	AC:60W/120W/ 240W; DC:45W/88W/165W
Frequency response	80Hz-16kHz(±3dB)
T.H.D.	≤ 1%
S/N Ratio	MIC: ≥ 65dB Phantom: ≥ 65dB Line: ≥ 75dB AUX: ≥ 80dB
Power consumption	AC 230V:285W/600W ;DC 24V: 161W/312W
Input/Sensitivity	Mic : -52dBV balanced Phantom : -52dBV / 24V balanced Line : -10dBV balanced Aux : -20dBV unbalanced AMP IN : 0dBV unbalanced; TEL IN : -10dBV balanced
Output	COM , 4Ω , 25V ,70V , 100V
Zone out	Z1 ~ Z4 : 100V
Controls	4 Input volume controls; 1 Aux volume controls 2 Treble/Bass controls; 1 Master volume control 4 Zone out volume controls;5 Zone out selector switch(units with"S") 3 REC selector switch(models of recording functions)
BGM module	MP3 PLAYER MP3 PLAYER+RECORDING CD-201 MON/TEL ECHO
Dimensions(WxDxH)	420 × 260 × 88mm(The models without CD player) 420 × 330 × 88mm(The models with CD player)
Weight	10.2kgs(120W without CD player); 11.0kgs(240W without CD player) 11.8kgs(120W with CD player); 12.8kgs(240W with CD player)

## BLOCK DIAGRAM

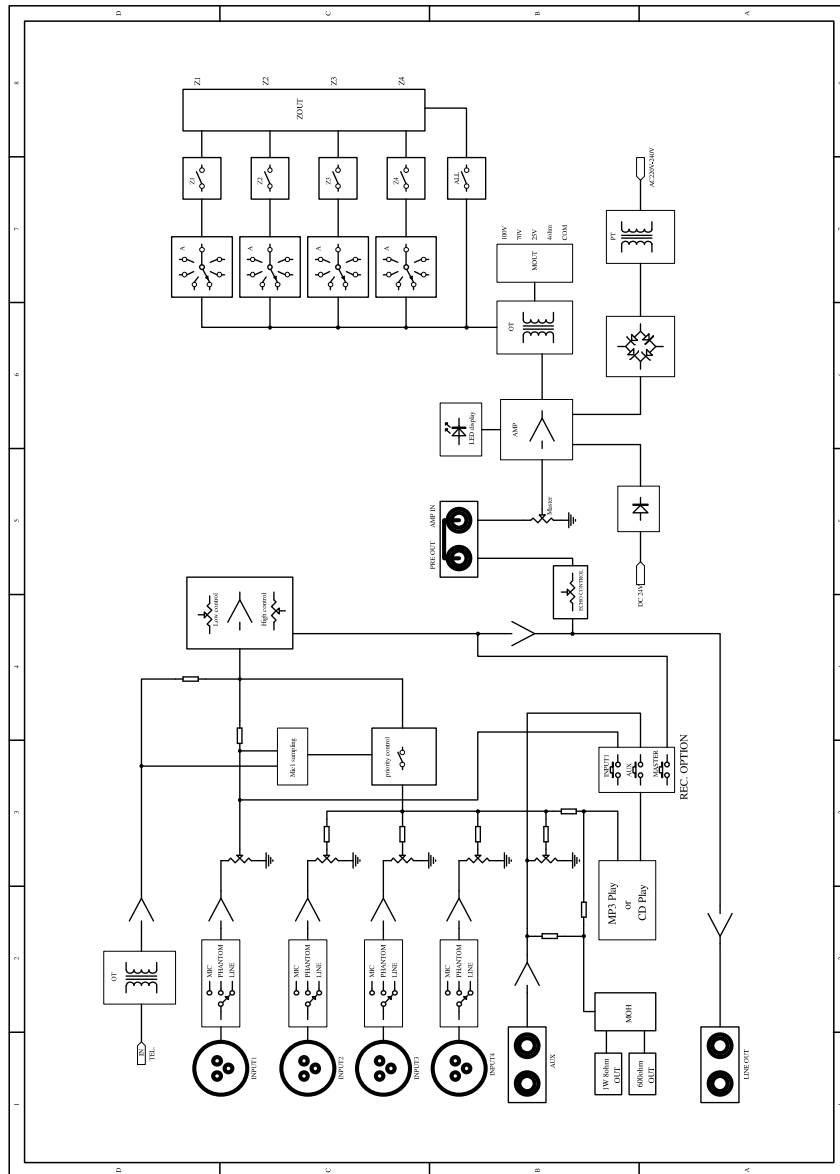

## INTRODUCTION

There are many models of MPA and PA series which have 120W&240W in power. They are professionally designed for schools, department stores and shopping centres.

More kinds of protection for the new series: such as overload, short-circuits of output, overheat; and you can use it safely and freely. We also design a fan to protect the power amplifier. The two new series have many acoustic modules, such as MP3 player and recording, CD-201, ECHO, telephone paging and monitor for option.

Each input volume can be controlled with the corresponding individual input volume control, and can be adjusted by means of a master volume and individual bass and treble tone controls. Emergency operation can be made of DC power source 24V, even when AC power fails. They have good performance and supply the excellent quality of sound. Besides, users can operate easily.

**Notes:** letter "M" means having built-in MP3 player; "R" means having recording function; "S" means having zone paging, "RS" means Mp3 player & recording + zone paging, "2" means CD-201. And MP3 player has USB interface & SD/MMC cards or has only USB interface for customer to choose.

**Features:**

1. Output: RMS 120W;240W
2. 2 Tones (BASS/TREBLE); 5 Input volume controls; 1 MASTER;
3. There are various modules like CD/TURNER/MP3/ECHO/TEL. for option.
4. MP3 player and recording; SD/USB interface
5. MONITOR function; Recording select function;
6. Impedance output is  $4\Omega$ ; constant voltage output is 25V, 70V, 100V; output level display
7. 4 MIC (XLR) inputs; MIC/LINE/PHANTOM exchange SW; 1 AUX (RCA) INPUT
8. PRE output and AMP input and Line out;
9. 4 ZONE paging with individual volume control and 1 ALL control of zone paging.

Note: The units of ECHO function have three MIC inputs.

## CONTROL ELEMENTS

Take the below model with MP3 player & recording + zone paging + ECHO for example.

### I. FRONT PANEL

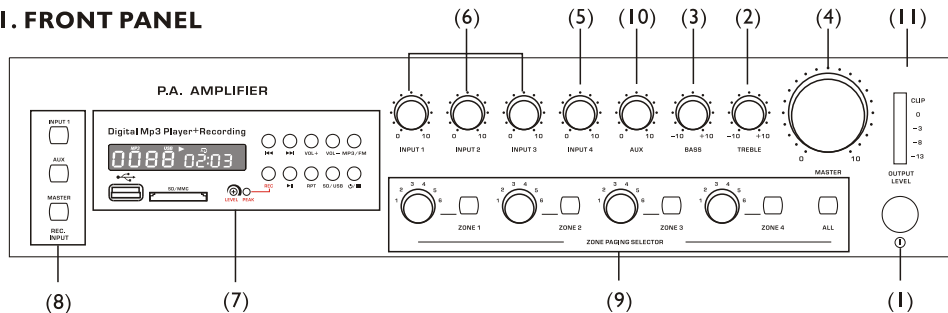

#### (1) POWER SWITCH

The main power can be switched on or off with it.

#### (2) TREBLE

Use the knob to control the high frequency at the range of  $\pm 10$ dB. Turn clockwise to boost and counterclockwise to attenuate the treble response. Tone is flat at centre.

#### (3) BASS

Use the knob to control the low frequency at the range of  $\pm 10$ dB. Turn clockwise to boost and counterclockwise to attenuate the treble response. Tone is flat at centre.

#### (4) MASTER

This knob is used to adjust the overall gain of the unit.

#### (5) AUX VOL knob

The knobs are used to adjust the gain of AUX. Adjust clockwise to increase the volume while adjust counterclockwise to decrease the volume .

#### (6) INPUT 1-3 VOL Knobs

The knobs are used to adjust the gain of input 1-3 respectively. Adjust clockwise to increase the volume while adjust counter-clockwise to decrease the volume.

#### (7) MP3 MODULE

Regarding its function and operation, please see the BGM module description in detail.

**Note:** MP3 player, recording, CD-201 and CD-901 are assembled to different units of the series.

#### (8) REC SELECTOR

In the status of recording, press INPUT 1 to record the sound source of INPUT 1, press AUX to record sound source of AUX, press MASTER to control all inputs. Only units with recording function have these control keys.

#### (9) ZONE PAGING SELECTOR

- 1) Switch on the equipment and start the player by pressing the (E) key.
- 2) The player will activate and the display will light up, indicating whether there is already a compact disc in the drive or not.
- 3) Press the key again to close the drive. The display will show the total number of tracks.
- 4) The first track starts to play out automatically.  
If this does not happen, press(I).

#### \*.mp3 files

As already described for audio CDs, the \*.mp3 files will start to play automatically one the CD has been inserted into the CD drive or after inserting a USB key in the socket provided for it (M). With the drive at a standstill, the display will show the number of folders present on the disk and the total number of tracks.

To switch from the CD mode to the USB mode and vice versa, press (H).

**NOTE:** To stop playing, press(N) once. If you press (D) the disk will be ejected, whether the player is off or is playing.

#### Description of the functions

##### A) REPEAT and RANDOM functions

These functions allow one or more tracks to be repeated as required or random selection of the track to be played.

To switch from one mode to another simply press (G).

Three symbols are associated with this mode:

**.REP** To repeat the track selected.

**.ALL** To repeat all the tracks.

**.RAN** To play out the tracks in random order.

##### B) Normal playing

This is the standard operating mode, that is to say, playing the tracks in the pre-defined order. Press (I) to start playing track 1.

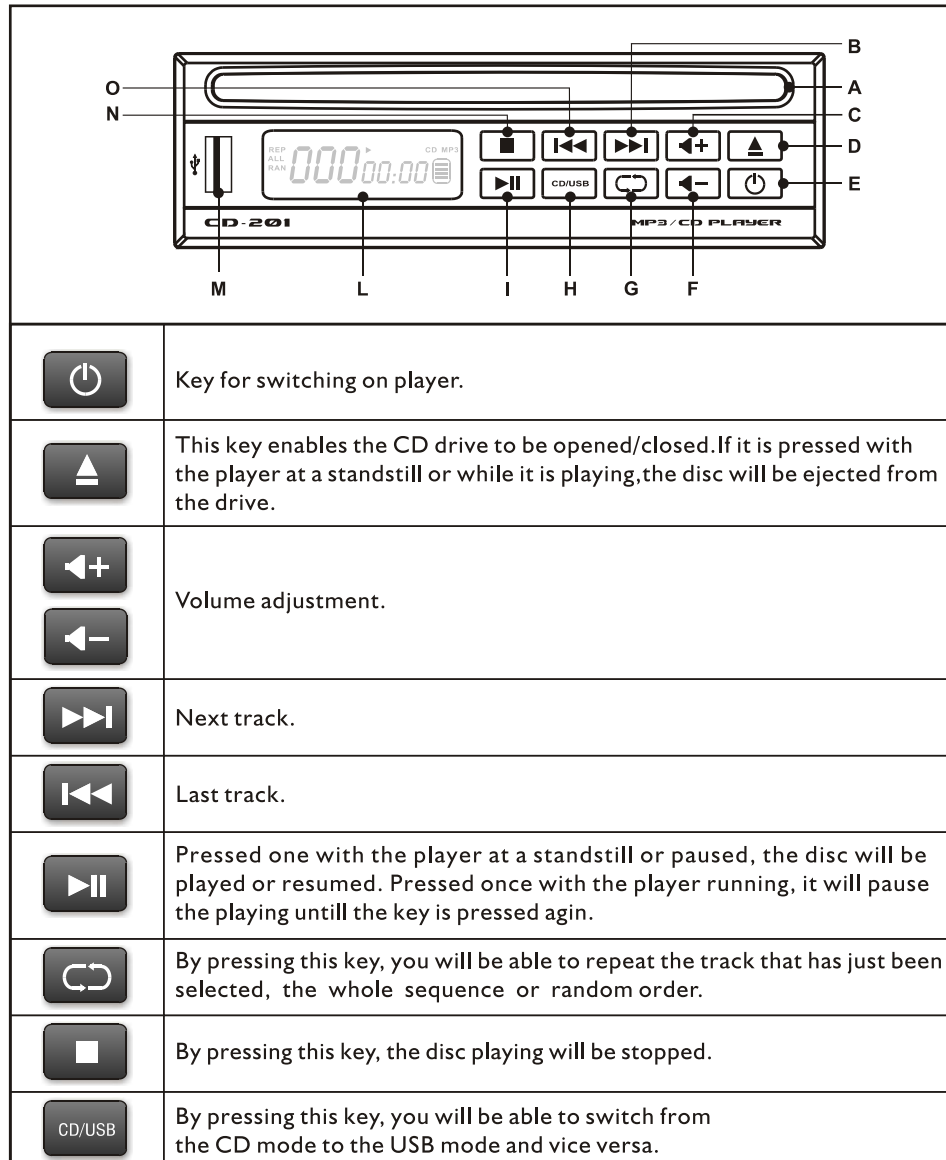

## 3. CD-201

USING THE CD/MPE PLAYER  
DESCRIPTION OF THE CONTROLS

There are four zone paging controls and one mains zone paging control. Press ZONE1-4 keys, the output terminals in front panel have respective output. And rotate the four knobs to control the volume by adjusting clockwise to boost the volume and adjusting counterclockwise to attenuate the volume. When the "all" key is switched on, the four zone paging controls work simultaneously and the volume is at the maximum value.

**(10) ECHO FUNCTION**

It is used to control ECHO.

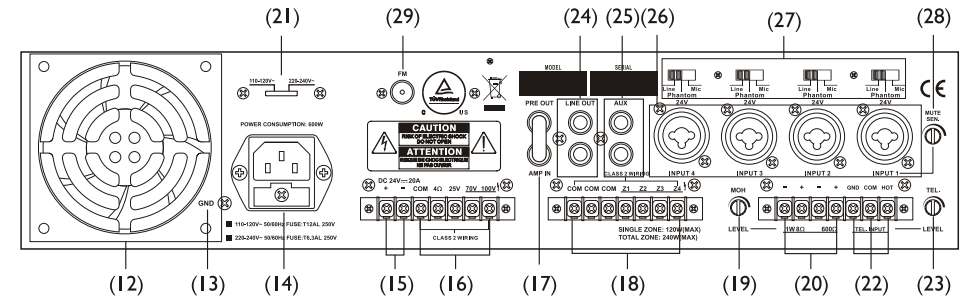
**(11) Output level indicator and power LED.****2. REAR PANEL****(12) FAN**

It is used to blow off heat and cool when the temperature rises during operation.

**(13) GND**

It is ground connection.

**(14) AC JACK**

This connector is meant for connection of the supplied main cord. Do not insert the power cord into this unit until voltage has been correctly set.

**(15) DC INPUT**

It is used for DC power supply for 24V. You should pay attention to the polarity.

**(16) OUTPUT TERMINALS**

Connections for low impedance  $4\Omega$  speakers; connections for constant voltage 25V, 70V or 100V speakers.

**(17) AMP INPUT/PRE OUT**

Jacks AMP IN and PRE OUT to insert an audio unit for signal processing.

**(18) ZONE OUTPUT TERMINALS**

There are 4 zone output terminals which are controlled by key (9).

**(19) MUSIC ON HOLD VOL**

It is used to monitor volume of black ground music and AUX.

**(20) MUSIC ON HOLD OUTPUT**

It is connected to monitor the signal of AUX input.

**(21) POWER SELECT SWITCH**

There are two voltages to choose: 115V and 230V.

**(22) TELEPHONE PAGING**

It is connected with telephone.

**(23) TELEPHONE LEVEL**

It controls the level of telephone input.

**(24) LINE OUT**

It is connected to recorder and pass on mixed signal.

**(25) AUX IN**

It is used for AUX input.

**(26) INPUT 1-4**

They are used for both balanced and unbalanced inputs.

**(27) MIC/PHANTOM/LINE SELECT SWITCH**

It is turned to left for MIC, middle for PHANTOM, and right for LINE.

**(28) MUTE/SEN**

With MIC I or TEL paging working, all other input signals are muted.

**(29) FM ANT**

**1.MP3-200(with USB)**

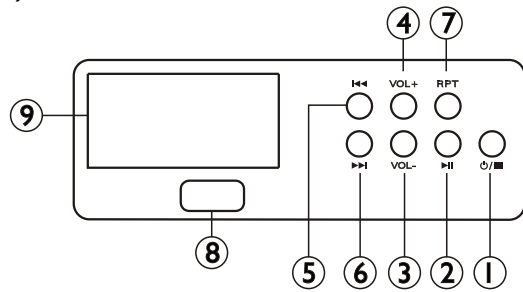

- ① POWER/STOP: press it to power on or off.
- ② PLAY/PAUSE: press it to play or pause.
- ③ VOL-: reduce the volume with it.
- ④ VOL+: add the volume with it.
- ⑤ PRE  
In the status of play or pause, the model plays next song when you press NEXT button.
- ⑥ NEXT  
In the status of play or pause, the model plays previous song when you press PRE button.
- ⑦ REP  
After press REP button, you can select the below four repeat modes.  
REP ALL: repeat all tunes in the memory.  
REP I: repeat one tune.  
Ordering play.  
Random play.
- ⑧ USB interface  
It is connected to USB.
- ⑨ DISPLAY  
The status of playing shows in the display.

**2.MP3-300(with USB, SD/MMC cards)**

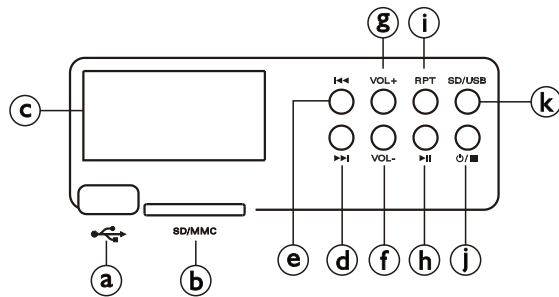

①	USB CONNECTOR	Insert USB player	①	VOL-	Press this key to decrease the sound level.
②	SD/MMC CARD CONNECTOR	Insert SD/MMC Card	②	VOL+	Press this key to increase the sound level.
③	DISPLAY	Display the status of USB playing	③	▶▶	Press this key to start to play
④	▶▶	Play the next title	④	RPT	Press this key to repeat the title
⑤	◀◀	Play the last title	⑤	⏻/■	Press this key to switch the power or stop the title
			⑥	SD/USB	Press this key to select the SD Card or USB Player

**BACK GROUND MUSIC MODULE DESCRIPTION**

**3.MP3-400 PLAYER+RECORDING**

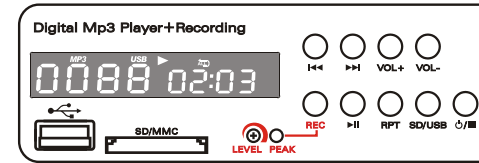

**4.MP3-500 PLAYER+RECORDING**



①		USB interface
②	SD/MMC	SD/MMC hole
③	DISPLAY	Display operation status of Mp3.
④	LEVEL	Control the volume of recording.
⑤	REC	After power on, press REC and prepare to record. Then select the save way with the USB/SD button .Press REC again. If "REC" lights about 3~4 times, record begins. During record, do not do other operations until press "STOP" to stop. If "Err" appears, press "STOP" to stop recording
⑥	▶▶	If the model is connected to USB or SD clip, it can make a selective play automatically after powered on. And it plays the USB equipment prior. When the model is in waiting status, it plays automatically after inserting USB save equipment or SD clip. When it is in a stop or pause, begin to play after pressing PLAY/PAUSE.
⑦	RPT	After press REP, you can select the below four repeat mode: Play in order: no picture displays; Repeat single: REP I; Repeat all: REP ALL; Random play: REP.
⑧	SD/USB	Select save device with the key USB/SD.
⑨	⏻/■	Hold POWER button for 3 seconds. When the display of mold lights, it means that the model is powered on. Hold the button for 3 seconds again. When the display of model goes out, it means it is powered off. Start to search playable equipments after powering on.
⑩	VOL-	Press VOL- to decrease the volume and press VOL+ to increase the volume. Factory default : 10.
⑪	VOL+	Press VOL+ to increase the volume. Factory default : 10.
⑫	▶▶	In the status of play or pause, the model plays next song or previous one when press ▶▶ or ◀◀ , and the status has no change. It plays the next file or previous file when hold ▶▶ or ◀◀ for about 2 seconds, and the status is as before. When the current file is recording one, "FrE" appears in the display.
⑬	◀◀	In the status of play or pause, the model plays next song or previous one when press ▶▶ or ◀◀ , and the status has no change. It plays the next file or previous file when hold ▶▶ or ◀◀ for about 2 seconds, and the status is as before. When the current file is recording one, "FrE" appears in the display.
⑭	MP3/FM	MP3 or FM select.